

「たふもにゆ」



完成したら
「#たふもにゆってみた」
でSNSにアップしよう！

つくりかた (パーツ対応表)

※難易度…やや高 (大人で2~3時間かかります)

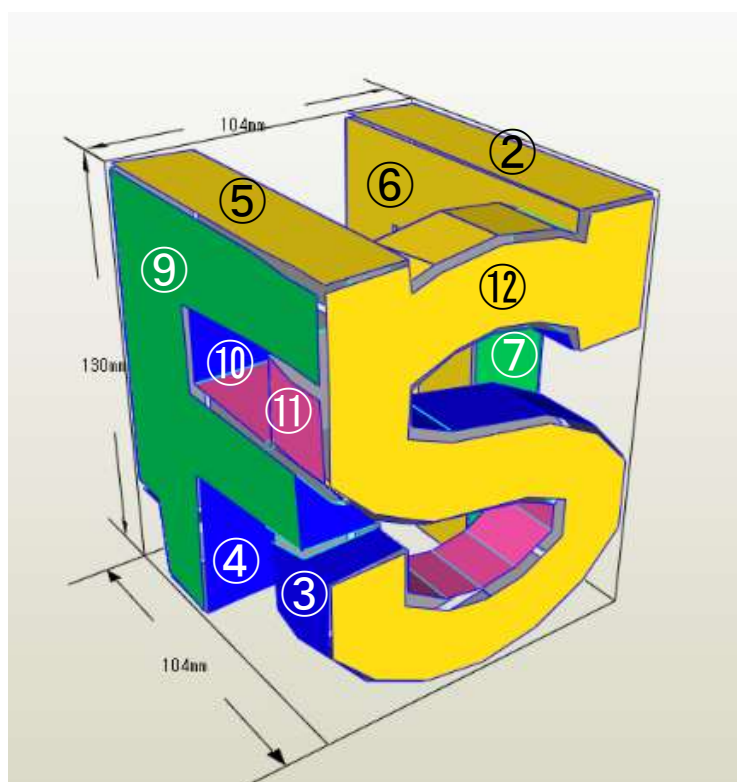
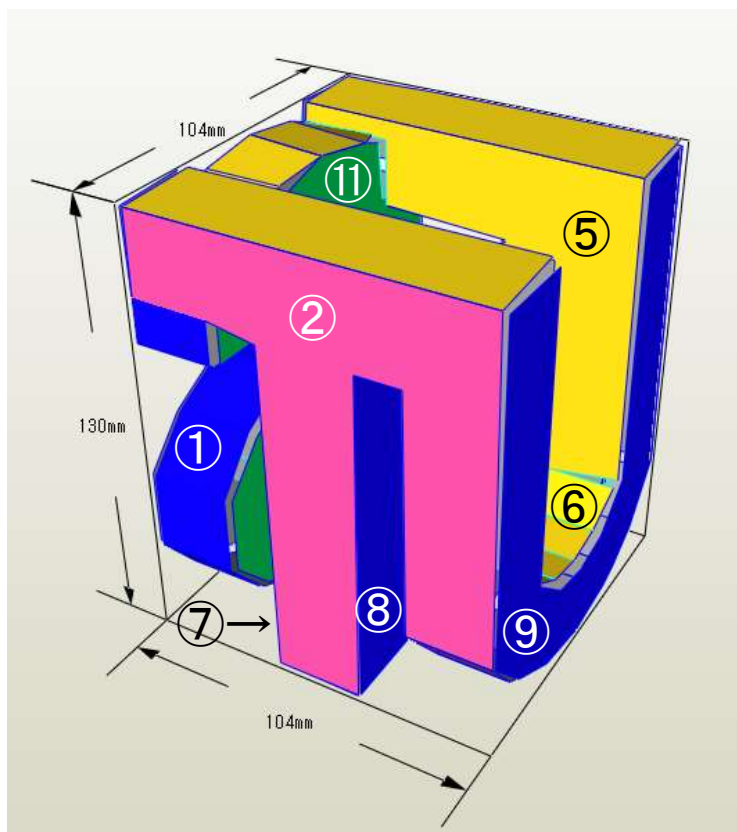

①

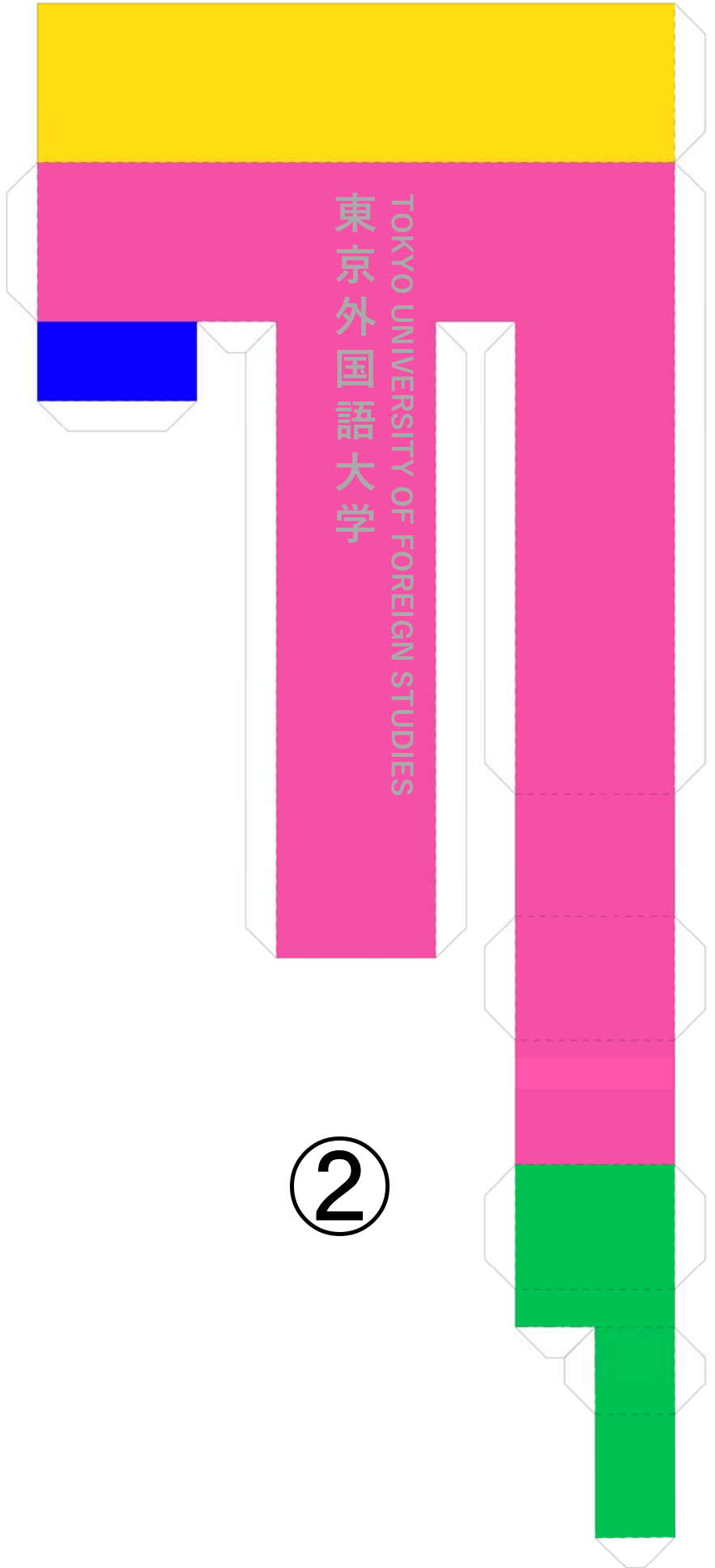
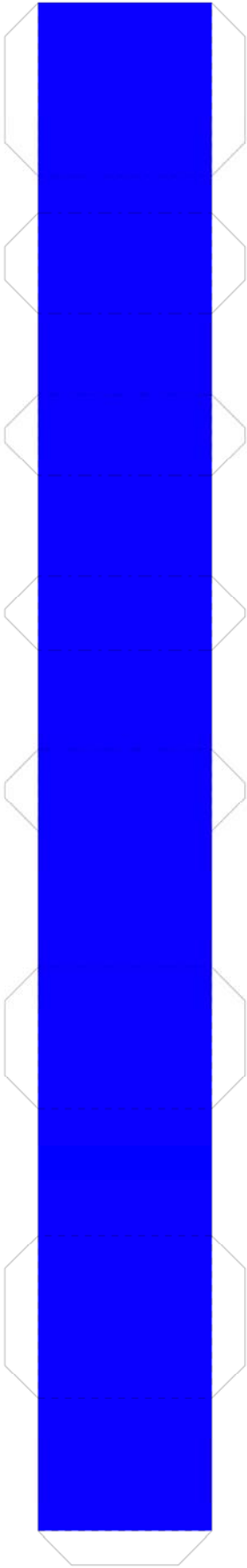

②

③

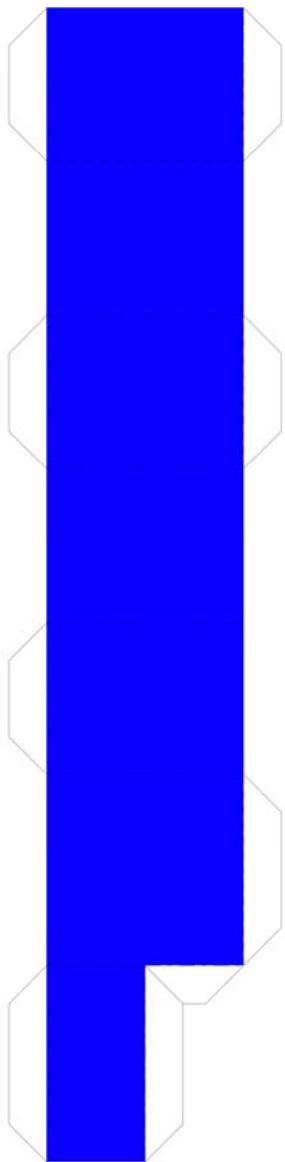

④

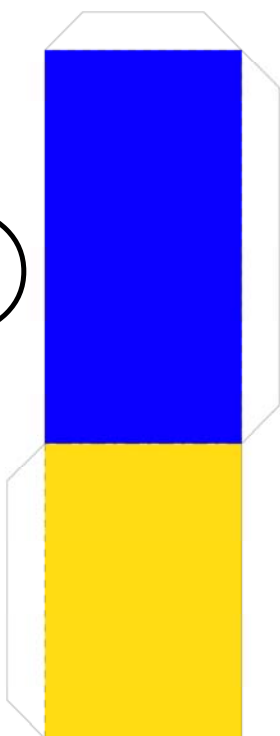

⑤

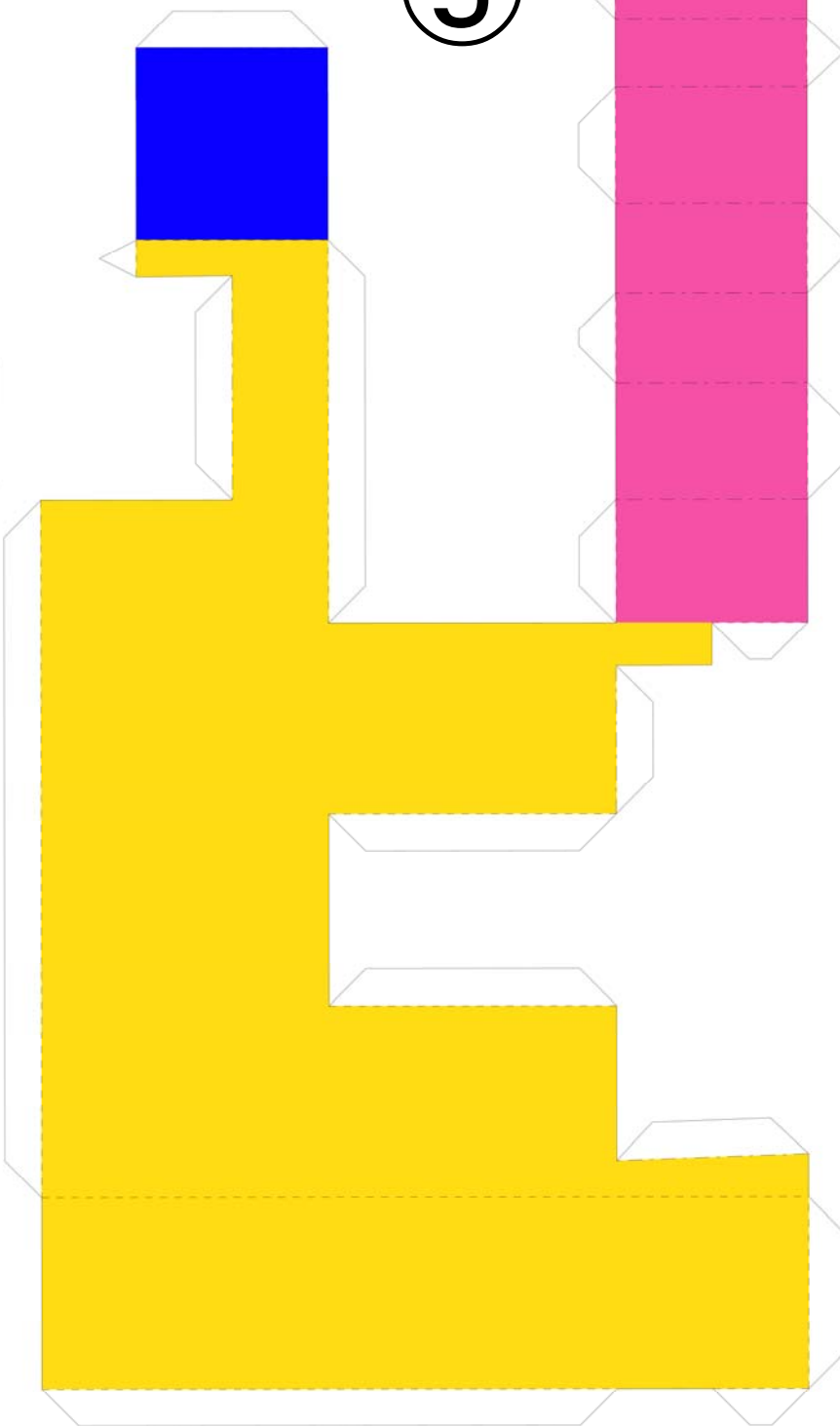
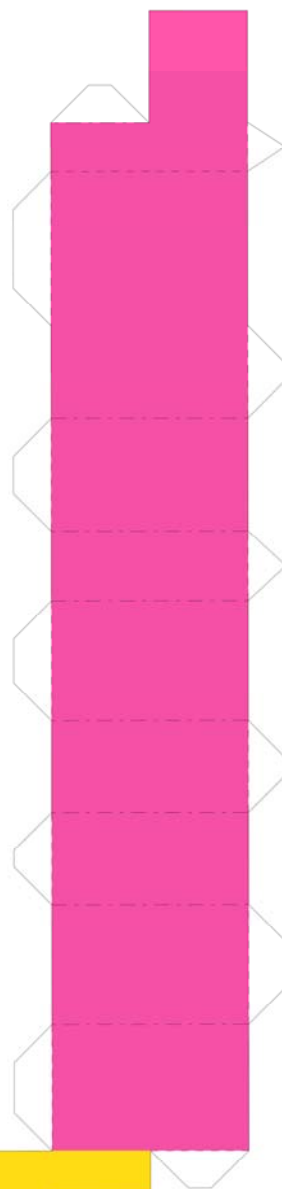

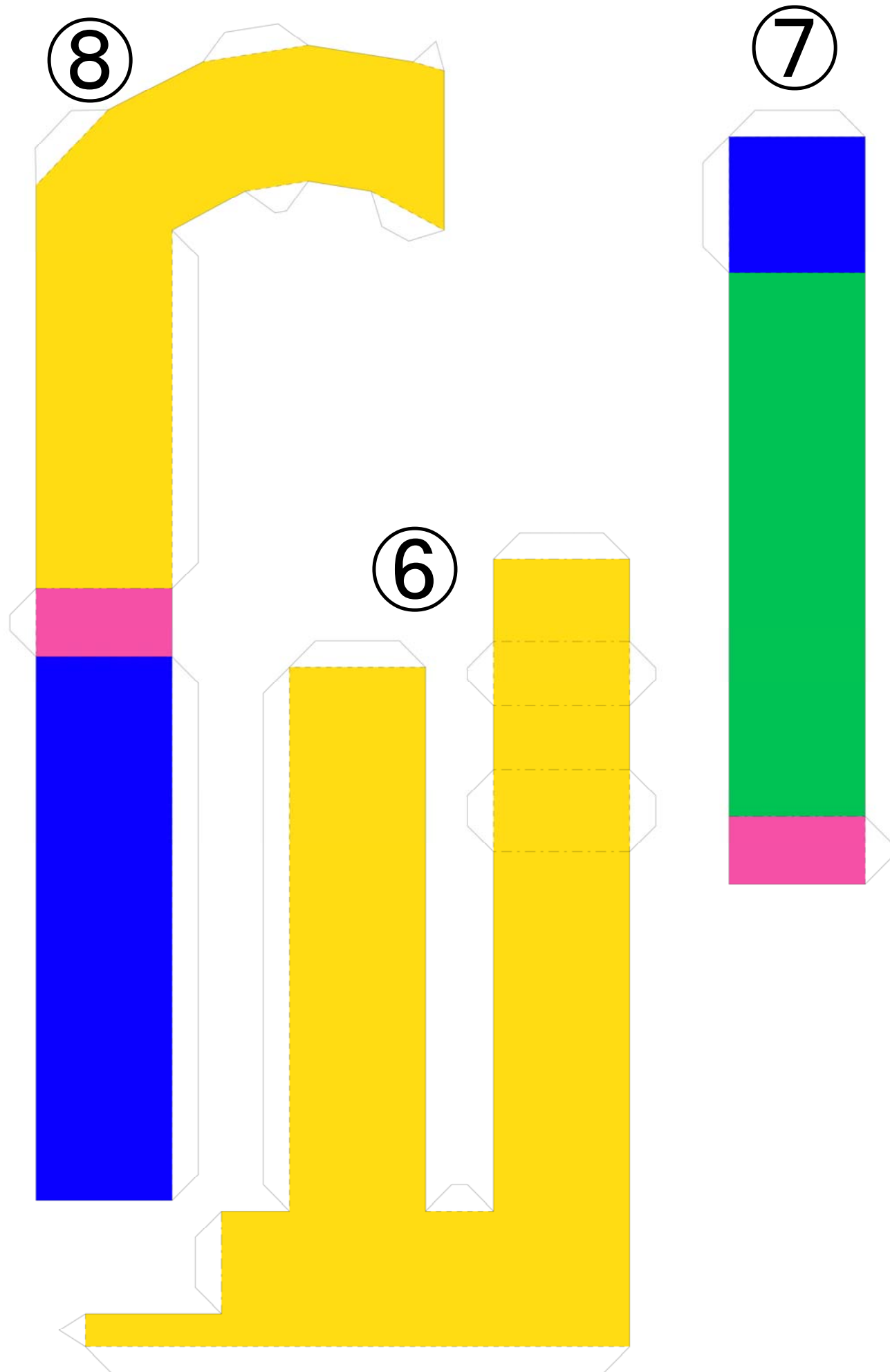

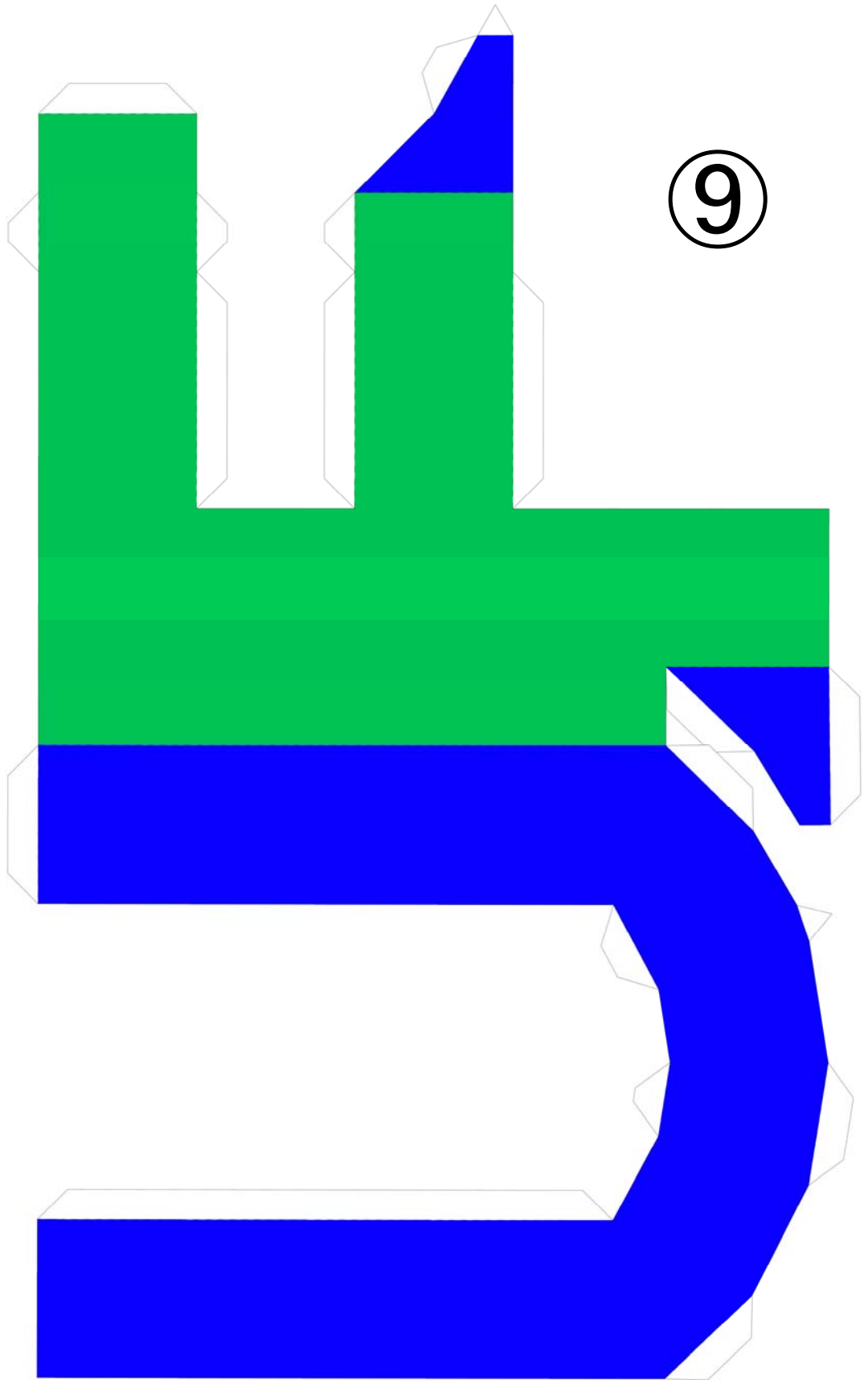

9

10

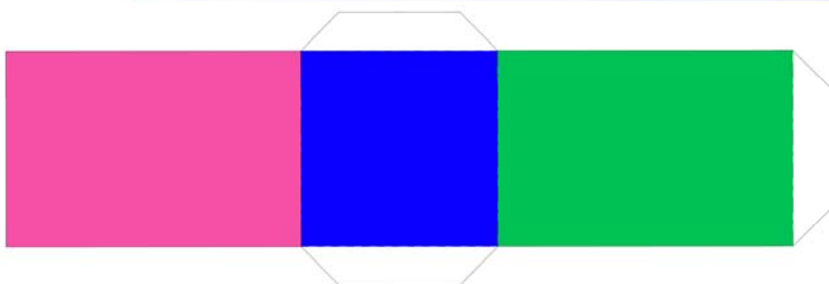

4/5 (2行 2列)

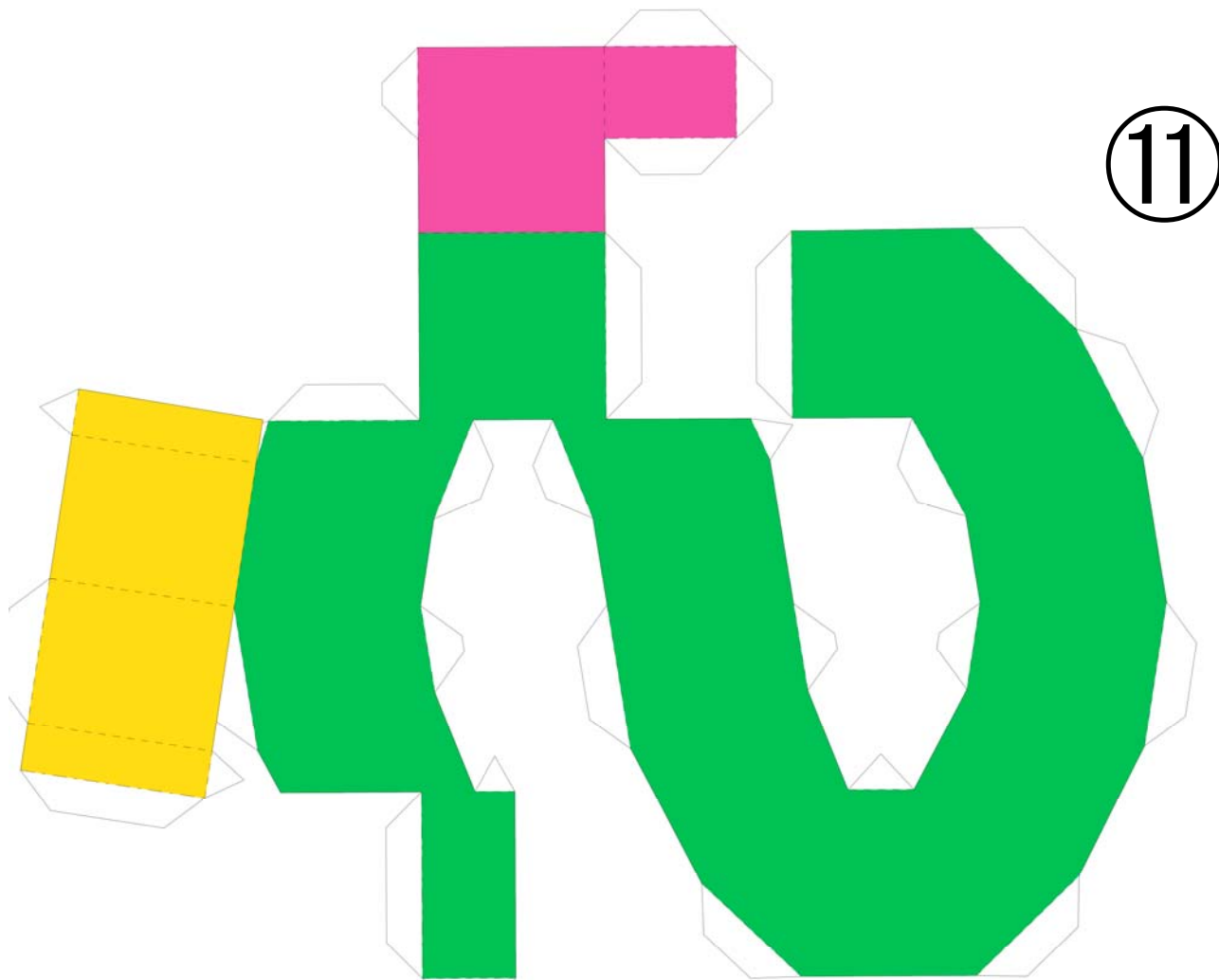

11

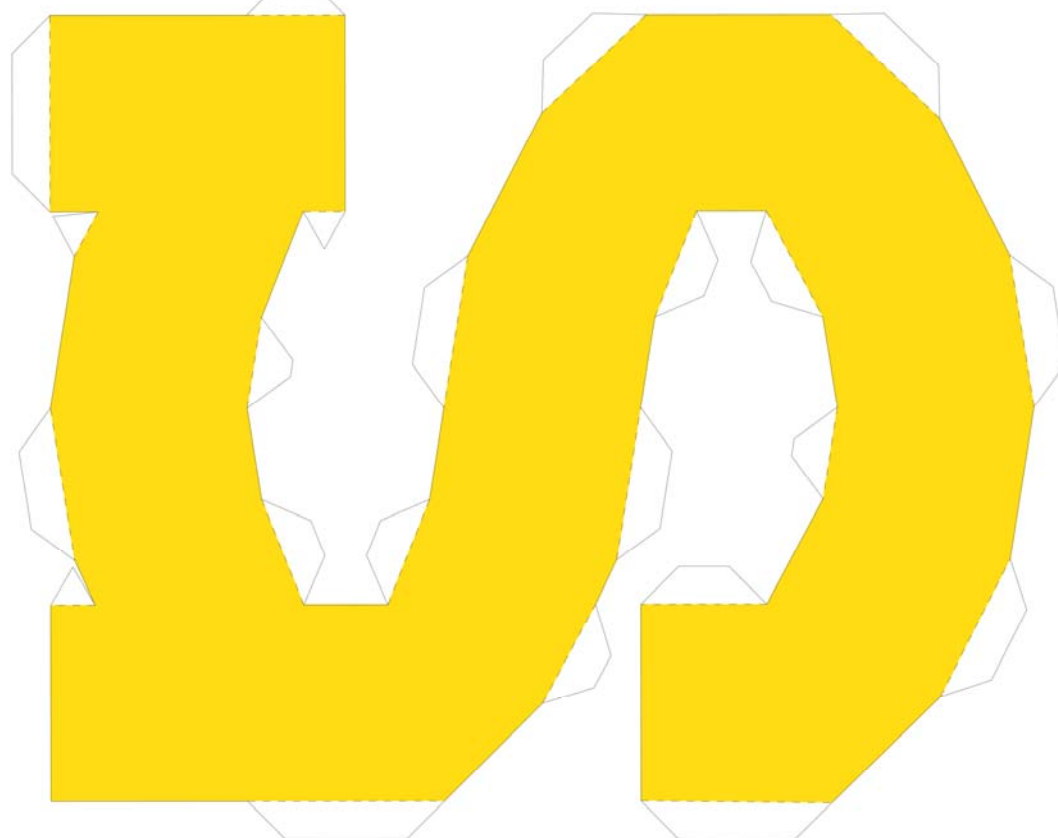

12